



R&DC-ACM

母材にセルロースナノファイバを添加した開織炭素繊維強化複合材料の疲労特性の向上



京都太郎, 大窪和也, 藤井透
今出川花子²⁾, 同志社二郎³⁾

1. 背景

炭素繊維強化プラスチック Carbon Fiber Reinforced Plastic

先行研究

平織CFRP



母材にセルロースナノファイバ (CNF) 添加



平織CFRP

空気式開織

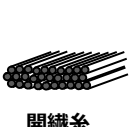
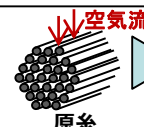

従来品よりも薄く
優れたプリプレグ
成形可能

疲労寿命への効果は？

目的

開織炭素繊維を強化材に用いたCFRP(開織CFRP)の母材にCNFを添加し、疲労特性に与える影響を明確化

2. 実験材料

2.1 CNF添加開織炭素繊維プリプレグ

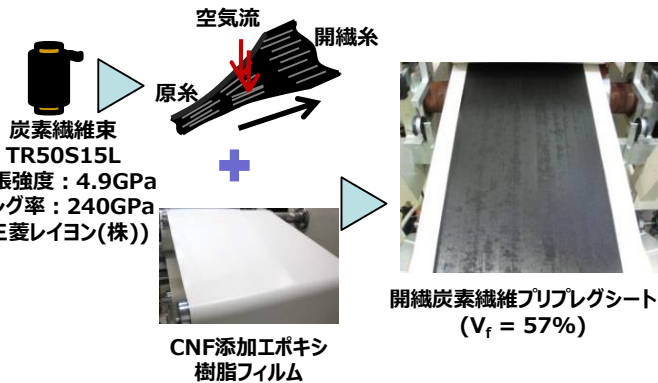

2.2 積層構成

作製したプリプレグシートを積層

未開織CFRP

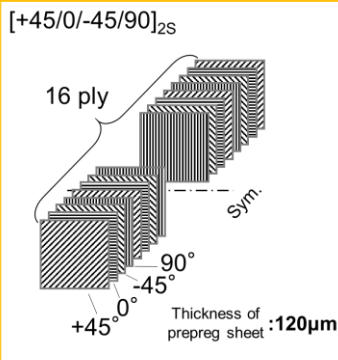

開織CFRP

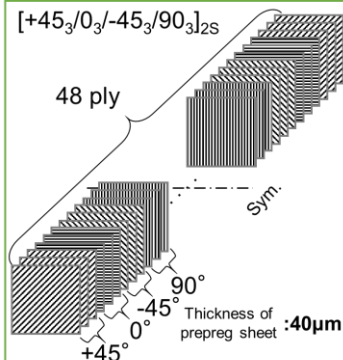

3. S-N線図

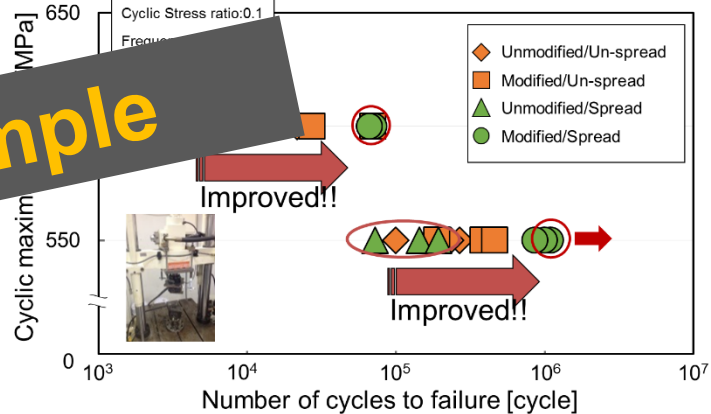

強化材に開織炭素繊維を使用 → CNFの添加によるCFRPの疲労寿命改善率大

4. 疲労破面様相

疲労破断後の破面をSEM観察

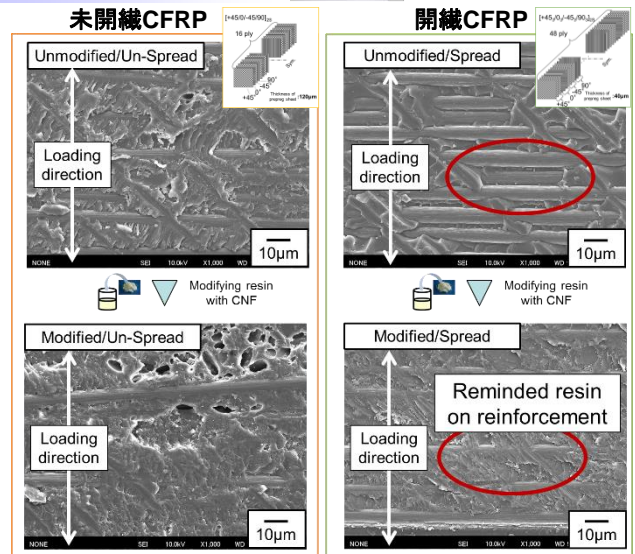

CNF添加開織CFRPの衝撃破面観察 (アイソット衝撃試験と同等手法で衝撃を与えた)

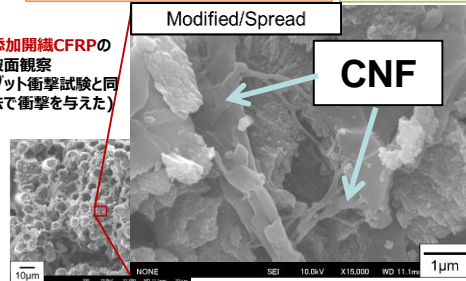

CNFが繊維束内部にまで存在

↓
CNFの母材添加によって開織CFRPの疲労寿命改善

5. 結論

強化材に開織炭素繊維を選択した場合には、未開織炭素繊維を選択した場合よりもCNFの母材添加による疲労寿命の改善効果が大きく得られることがわかった。

[謝辞] 本研究は、平成25年度文部科学省私立大学戦略的研究基盤形成支援事業 (同志社大学)の支援を受けた。



Mg/AL2O3界面反応を利用したナノ粒子分散 マグネシウム複合材料の微細組織制御

藤原弘, 京都太郎, 宮本博之, 今出川花子²⁾

Introduction

Mg composites containing fine Al₂O₃ particles were produced using a powder metallurgy technique and exhibited superior mechanical properties.

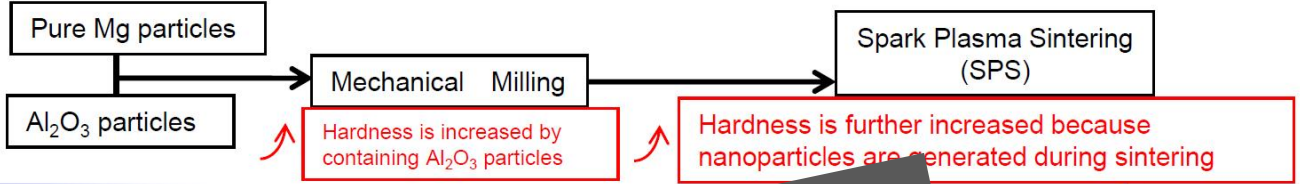

Aim

In this study, we investigated nanoparticle formation in detail. **But** We have not known the formation mechanism of nanoparticle

Experimental Procedure

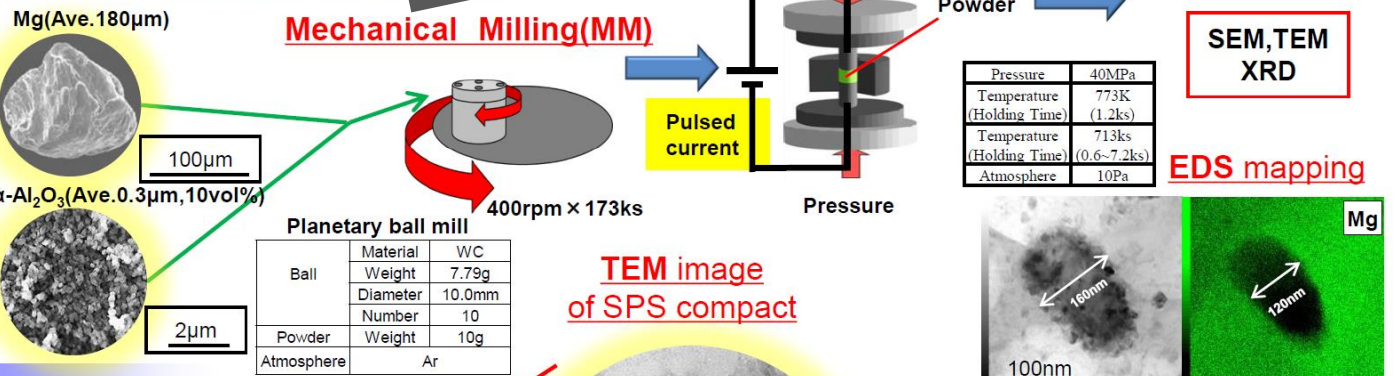

Results

SEM image of SPS compact

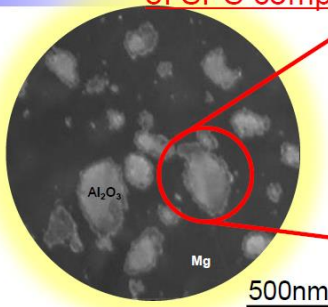

The interface between the Mg and Al₂O₃ is not clear.

XRD analysis

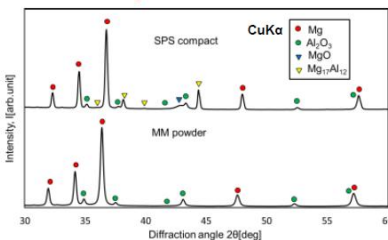

Interfacial reaction

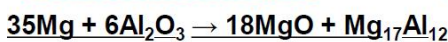

MgO and Mg₁₇Al₁₂ phases are formed via the SPS process.

TEM image of SPS compact

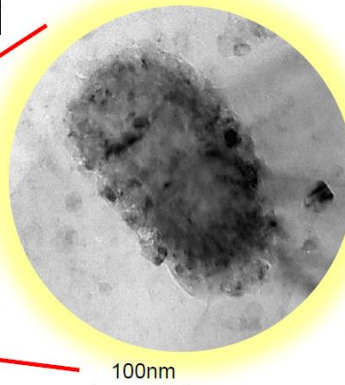

Equiaxed nanoparticles are formed at the interface between the Mg and Al₂O₃.

EDS Line Analysis of nano particle

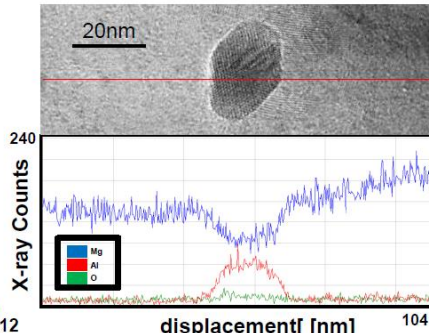

Mg₁₇Al₁₂ plate-like nanoparticle is formed in Mg matrix at the position of several hundred nm from Al₂O₃.

Evaluation method

SEM, TEM, XRD

EDS mapping

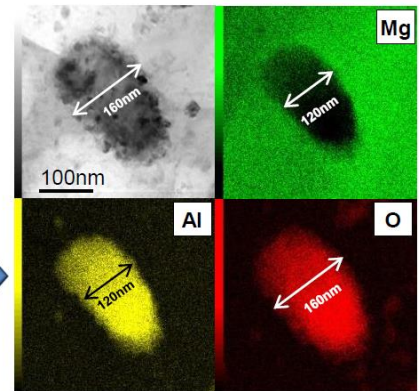

MgO particles were formed at the interface between the Mg and Al₂O₃.

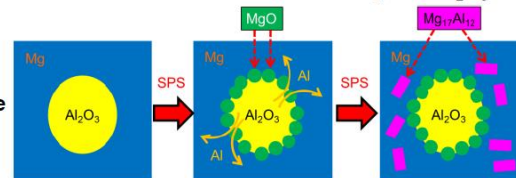

After reaching the solubility limit of Al to Mg, it reacts with the Mg matrix to form Mg₁₇Al₁₂.

Results

1. The Mg/Al₂O₃ composite was fabricated by mechanical milling and spark plasma sintering process.
2. the microstructure formation process during sintering is studied.
3. MgO with the size of about 10 nm is formed at the interface between Mg and Al₂O₃.
4. Mg₁₇Al₁₂ in Mg matrix is formed at the position of several hundred nm from the Al₂O₃ particle.